



KEY FEATURES

- Designed for marine and industrial applications
- High-output linear LED replacement for legacy vapor-tight lights
- Field serviceable light engines, power supply, and housing elements
- Copper-free, extruded aluminum housing with polycarbonate lens
- Approved for through-wiring of multiple units on a single circuit
- Angle adjustable mounting bracket allows for 360° rotation
- Built-in junction area for simplified termination



TECHNICAL SPECIFICATIONS

HOUSING	Copper Free Aluminum and Polycarbonate Lens
MOUNTING	See Page 3 for MOUNTING OPTIONS
INPUT VOLTAGE	AC & BB: 120-277 VAC HV: 347-480 VAC
RATED POWER	See Page 2 for DETAILS
RATED CURRENT	See Page 2 for DETAILS
CONNECTIONS	2x 3/4" NPT Entries
TEMPERATURE RANGE	SEE PAGE 2 FOR DETAILS (Case ~30°C above ambient)
CERTIFICATIONS	Certified to UL 1598, UL 1598A & UL 8750; CSA 22.2 No. 250.0; CSA 22.2 No. 250.13
INGRESS PROTECTION	IP66 Suitable for wet locations. Marine Outside Type (Salt water).
COLOUR TEMP RANGE	50: 5000K Special Order: 2700-6500K
CRI VALUE (MIN)	70
TOTAL LUMENS	See Page 2 for DETAILS
LUMEN MAINTENANCE	LM-80 > 60,600 hrs
WEIGHT	NL2: 5.3 kg (12 lb) NL4: 8.6 kg (19 lb)

* The ambient temperature during lifetime, lumen and chromaticity determination is 25°C ± 1°C.

DIMENSIONS

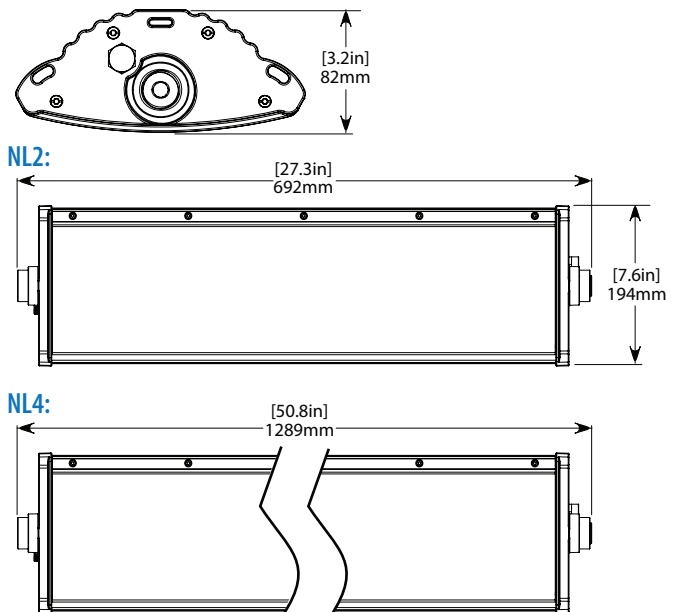

WARRANTY

Five (5) year limited warranty to the original purchaser. The warranty covers defects in materials and workmanship under normal use and service.

For additional information see:
<https://nemalux.com/legal>

ELECTRICAL RATINGS

MODEL	INPUT VOLTAGE	RATED WATTAGE [Watts]	RATED VOLTAGE [Volts]	FREQUENCY [Hz]	AMBIENT TEMP. RANGE [°C]	TOTAL LUMENS
NL2S	AC	36	120-277	50/60	-40 to 50	3,970
	BB	36	120-277	50/60	-40 to 50	3,970
	HV	36	347-480	50/60	-40 to 50	3,970
NL2H	AC	52	120-277	50/60	-40 to 53	5,143
	BB	52	120-277	50/60	-40 to 50	5,143
	HV	52	347-480	50/60	-40 to 53	5,143
NL2X	AC	69	120-277	50/60	-40 to 50	7,965
	HV	69	347-480	50/60	-40 to 50	7,965
NL4S	AC	85	120-277	50/60	-40 to 50	8,697
	BB	85	120-277	50/60	-40 to 50	8,697
	HV	85	347-480	50/60	-40 to 50	8,697
NL4H	AC	105	120-277	50/60	-40 to 45	10,470
	HV	105	347-480	50/60	-40 to 45	10,470
NL4X	AC	135	120-277	50/60	-40 to 35	14,313
	HV	135	347-480	50/60	-40 to 35	14,313

FIXTURE COMPARISON

Size: Length: Rating: Lamp Quantity: Est. Power: Est. Lumens LED Cross:	T12				T8				T5						
	4 foot		8 foot		4 foot			8 foot		4 foot					
	Standard	High Output	Standard	High Output	Standard	High Output	Standard	High Output	Standard	High Output	Standard	High Output	Standard	High Output	
Lumens	3,200	6,400	6,000	8,100	3,200	6,400	8,600	4,300	8,800	9,100	3,200	6,400	9,600	6,600	13,200
NL2-S	X				X			X			X				
NL2-H			X												
NL2-X		X		X		X						X		X	
NL4-S		X		X		X	X		X			X		X	
NL4-H										X			X		
NL4-X															X

PHOTOMETRICS

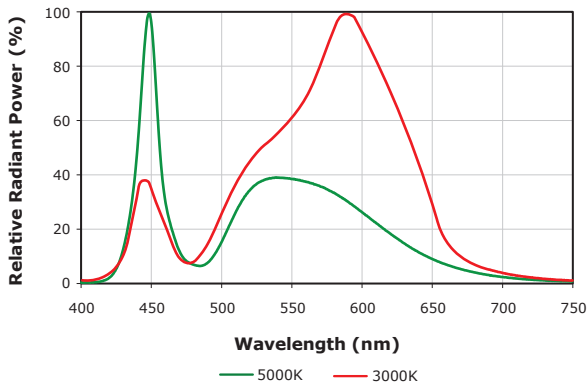

DIMMING

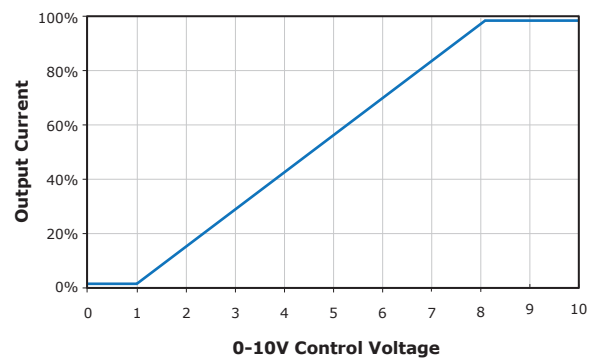

- Driver will source a maximum of 200uA for control needs
- Controller must sink current from the 0-10V control leads

MOUNTING OPTIONS (Ordered Separately)

SURFACE MOUNT (Optional)



SUSPENDED MOUNT

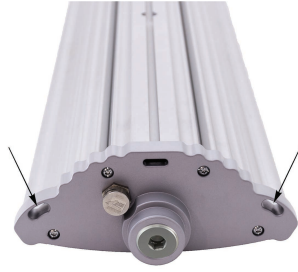

Two 6.5mm x 10 mm slots on each end for suspension hardware (not provided).

ANGLE ADJUSTABLE MOUNT (Optional)



Easy field 360° angle adjustment with 3mm Hex Key.

MOUNTING DIMENSIONS

NL2 - SURFACE MOUNT : 5.3 kg | 12.0 lbs (Optional Accessory)
(304 Stainless Steel)

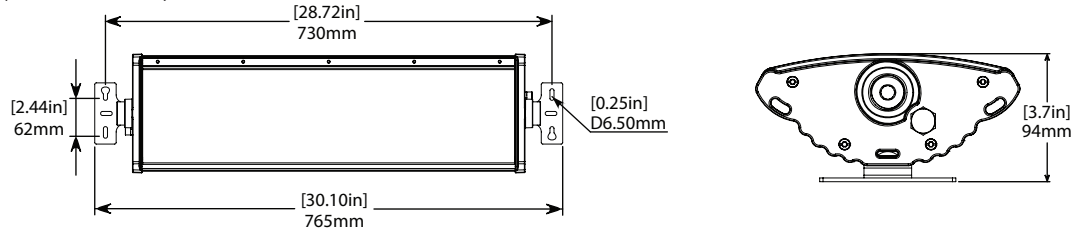

NL4 - SURFACE MOUNT : 8.6 kg | 19.0 lbs (Included Standard)
(304 Stainless Steel)

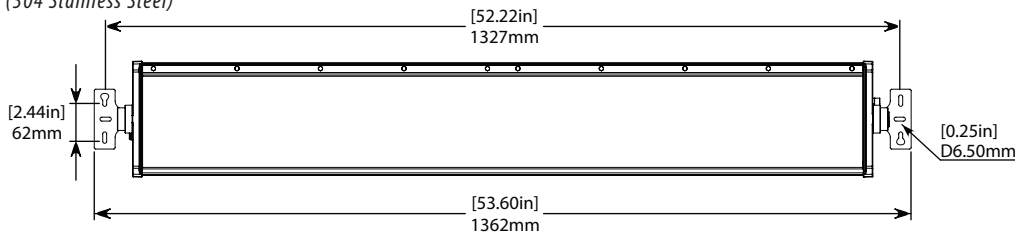

NL2 - ANGLE ADJUSTABLE MOUNT (NL-AM) : 5.3 kg | 12.0 lbs (Optional Accessory)

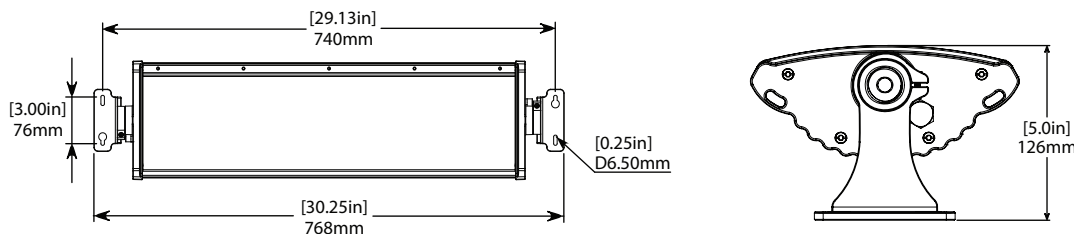

NL4 - ANGLE ADJUSTABLE MOUNT (NL-AM) : 8.6 kg | 19.0 lbs (Optional Accessory)

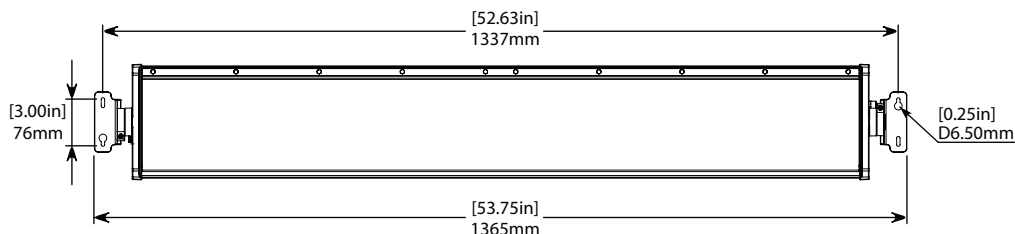

ORDERING INFORMATION

PROJECT NAME		TYPE
PROJECT LOCATION		
COMMENT		DATE
PREPARED BY		

MODEL SELECTOR

Sample Number: NL2-X-50-WC-GY-GN-AC

MODEL	OUTPUT	COLOUR	OPTIC	FINISH	LOCATION	POWER
-	-	-	-	GY	GN	-
NL2 NL4	S - Standard H - High Output ² X - Extra High Output ²	50 - Cool White (5000K) Special Order: 27 - 2700K ¹ 30 - 3000K ¹ 35 - 3500K ¹ 40 - 4000K ¹ 57 - 5700K ¹ 65 - 6500K ¹	WC - Wide Clear WF - Wide Frosted	GY - Grey Custom finishes available. Please contact for details. ¹	GN - General Location	AC - 120-277VAC BB - 120-277VAC ^{2,3} w/ Battery Back-up HV - 347-480VAC

ACCESSORIES (Ordered Separately)

Sample Number: NL-AM-GY

ACCESSORY	FINISH
-	-
NL-SM - Surface Mount NL-AM - Angle Adj. Mount	GY - Grey Custom finishes available. Please contact for details. ^{1,4}

NOTES:

1. Minimum order quantities, additional costs and lead times may apply.
2. Battery Backup (BB)
 - NL2S - 20% 90 min
 - NL2H - 15% 90 min
 - NL4S - 10% 90 min
 - Not available on NL2-X, NL4-H, NL4-X
3. BB details
 - Input Current: 0.07 A
 - Input Wattage: 4 W
 - Recharge Time: 24 – 48 Hrs.
4. Custom finishes only available for NL-AM